

CHAMPIONS® MULTI-UNIT

STEP-BY-STEP INSTRUCTION

MANUAL FOR THE MULTI-UNIT ABUTMENT



N° 1
in **MIMI®**-
Flapless

Gentle & Reliable Implantation Method

1 OVERVIEW OF MODULES

Abutment Multi-Unit 0°



Gingival height 1 mm
ø 5.2 mm | Height 3.9 mm
Ref. 3108



Gingival height 3 mm
ø 5.2 mm | Height 5.9 mm
Ref. 31083



Gingival height 5 mm
ø 5.2 mm | Height 7.9 mm
Ref. 31085

Abutment Multi-Unit 17°



Gingival height 1 mm
ø 5.2 mm | Height 4.0 mm
Ref. 3109



Gingival height 3 mm
ø 5.2 mm | Height 6.0 mm
Ref. 31093



Gingival height 5 mm
ø 5.2 mm | Height 8.0 mm
Ref. 31095

Abutment Multi-Unit 30°



Gingival height 1 mm
ø 5.2 mm | Height 3.4 mm
Ref. 3110



Gingival height 3 mm
ø 5.2 mm | Height 5.4 mm
Ref. 31103



Gingival height 5 mm
ø 5.2 mm | Height 7.4 mm
Ref. 31105



Multi-Unit Cap titanium
not rotation proof
ø 5.2 mm | Height 12.9 mm
Ref. 3111



Multi-Unit Cap titanium
rotation proof
ø 5.2 mm | Height 12.9 mm
Ref. 3111R



Multi-Unit Cap POM (calcinable)
not rotation proof
ø 5.2 mm | Height 12.9 mm
Ref. 3112



Multi-Unit LOC®
ø 5.2 mm | Height 5.0 mm
Ref. 3113



Protection Cap Multi-Unit
ø 5.2 mm | Height 5.0 mm
Ref. 31106



Fixation Screw Multi-Unit for Cap/ LOC®/
Protection Cap for: Ref. 3111, Ref. 3111R,
Ref. 3112, Ref. 31106, Ref. 3113
Ref. 3085M



Multi-Unit Positioning Aid
Ref. 31140



Insertion Aid Multi-Unit
Ref. 3062



Multi-Unit Laboratory Analog
Ref. 3114



Bonding Aid
ø 2.1 mm | Height 20 mm
Ref. 7000



Impression Post Multi-Unit
ø 4.9 mm | Height 13.0 mm
Ref. 31222



Fixation Screw Impression Post
Multi-Unit
ø 5.2 mm | Height 8.0 mm
Ref. 30852

2 APPLICATION FIELD



Multi-Units are indicated for screwable implant-supported prosthodontic restorations (no cemented superstructures "All-on-4" or "All-on-6").

Because of missing rotation protection, Multi-Units are not indicated for the restoration of single dental gaps.

In order to fit implant-supported restorations even in case of big insertion divergences, Multi-Unit-Abutments are available in 3 angles: straight (0°) and angled: 17° and 30°.

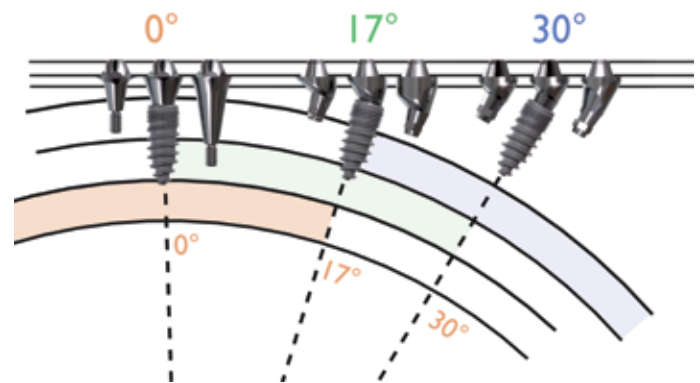

ADVANTAGES OF SCREWED PROSTHODONTIC RESTORATIONS

1. At the beginning of Implantology, the superstructures had been screwed because the implant-Abutment connection was not tight, which caused bacterial penetration into the implant body. You had to unscrew and clean the prosthodontic restoration regularly to avoid a peri-implantitis.

After the conical Abutment connections had been introduced, the connection was resistant to bacteria, and the prosthodontic restoration could be cemented. If you don't remove all cement residues when gluing, there will be a risk of iatrogenic cementitis. By screwing the superstructure, you can avoid cementitis.

2. If a removable prosthesis is fixed with Locators, the insertion divergence of implants may not exceed 15° because the Locators cannot compensate a bigger angle. In comparison: for a ball-head supported removable prosthesis, an insertion divergence can be adjusted up to 40°.

If Locators are placed on Multi-Units with a 30° angle in the maxilla, angles up to 45° can be compensated.

MULTI-UNIT SECONDARY COMPONENTS WITH AND WITHOUT ROTATION PROTECTION

The Multi-Unit Abutment system has been developed to fix an implant-supported prosthodontic restoration on at least 2 missing teeth (implants). The Abutments Multi-Unit 0° (Ref. 3108, 31083, and 31085) are not rotation-proof, but the angled Abutments Multi-Unit 17° (Ref. 3109, 31093, and 31095), and 30° (Ref. 3110, 31103, and 31105) are resistant to rotation. These details concern the implant-Abutment connection.

The secondary component Ref. 3111 is not rotation-proof, and the secondary component Ref. 3111R is rotation-proof.



PREPARATION & IMPRESSION 3

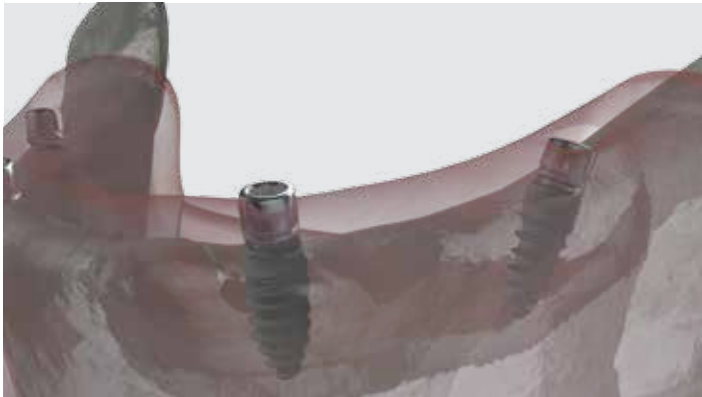

- 1** Initial situation: 4 Champions® (R)Evolution with the assembled Shuttles.

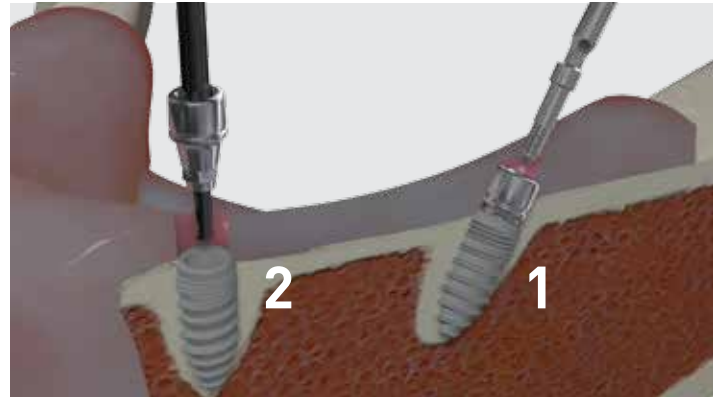

- 2** In order to remove the Shuttle, first unscrew the Screw (1). Then, remove the Shuttle with the Shuttle-Extractor (2).



- 3** In order to fit the Abutments Multi-Unit 0°, use a Positioning Aid, which consists of the following pieces: Insertion Aid Multi-Unit (Ref. 3062), Abutment Multi-Unit 0° GH1* (Ref. 3108), GH3 (Ref. 31083), or GH5 (Ref. 31085), and the Multi-Unit Positioning Aid (Ref. 31140).



- 4** Assemble in the following way: Insert the Multi-Unit Positioning Aid (Ref. 31140) through the Insertion Aid Multi-Unit (Ref. 3062) and screw it with an Abutment Multi-Unit 0° (Ref. 3108, 31083, or 31085), which facilitates the positioning. Screw it at 30 Ncm.



- 5** Place Positioning Aid in the implants inserted at 0°.



- 6** The Positioning Aid for angled Abutments consists of the following pieces: Multi-Unit Positioning Aid (Ref. 31140), Abutment Multi-Unit 17° or 30° with the corresponding gingival height, the Fixation Screw (Ref. 3085) as well as the Screwdriver (Ref. 3086 or 30861).



7 Assembled Positioning Aid for implants that are placed at an angle

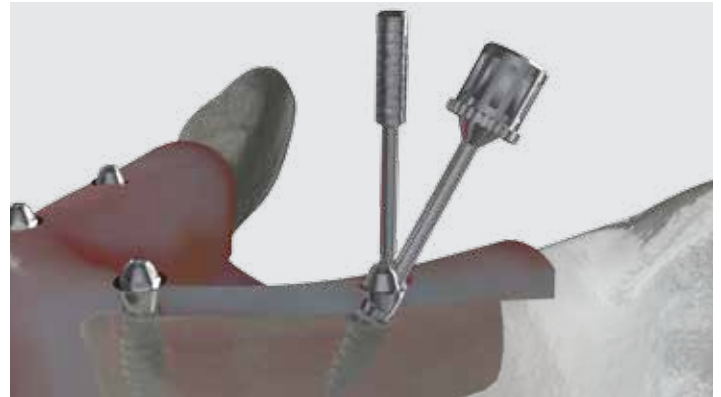

8 With the Multi-Unit Positioning Aid (Ref. 31140), the angled Multi-Units are positioned in the implant. They are fixed with the Screw at 30 Ncm.

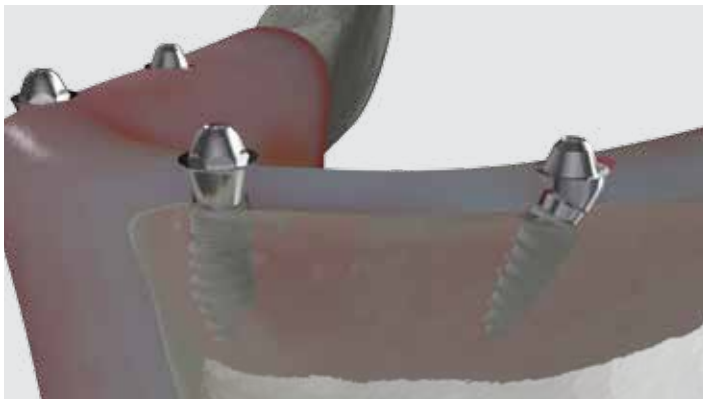

9 Assembled Abutments Multi-Unit



IMPRESSION 4

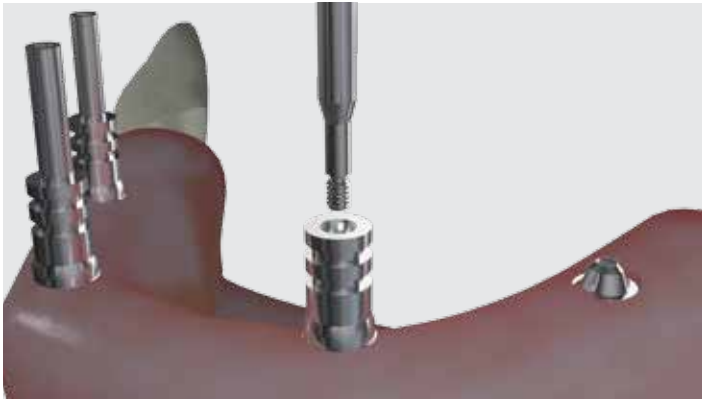

10 Take an impression by means of an open impression tray. Manually screw the Impressions Posts Multi-Unit (Ref. 31222) with the Fixation Screw Impression Post Multi-Unit (Ref. 30852).

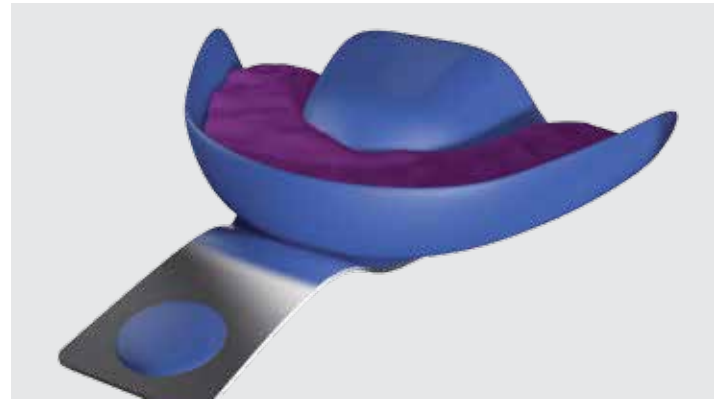

11 Prepare the impression tray for open bite registration or use an individual impression tray.

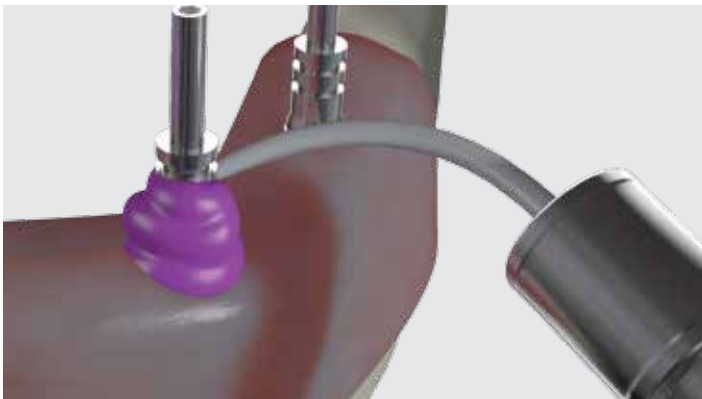

12 Mold the Multi-Units with a casting compound...

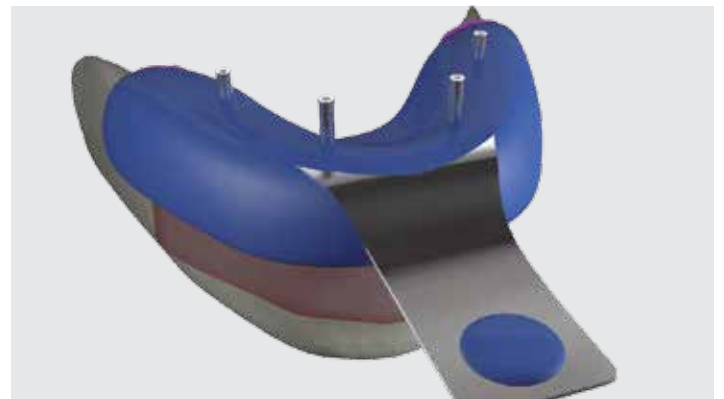

13 ...and take an impression with the impression tray. The Impression Posts Multi-Unit (Ref. 31222) remain in the impression. Unscrew the Screws (Ref. 31223). As soon as the compound is hard, unscrew the Impression Post screws.



14 After removing the impression tray, leave the Impression Posts WIN!® PEEK (Ref. 3122) in the impression.



15 Finally, fit the Protection Caps Multi-Unit (Ref. 31106). Screw them with a Fixation Screw Multi-Unit for Cap / LOC® / Protection Cap (Ref. 3085M) at 20 Ncm.

5 FABRICATING A FULL PROSTHESIS

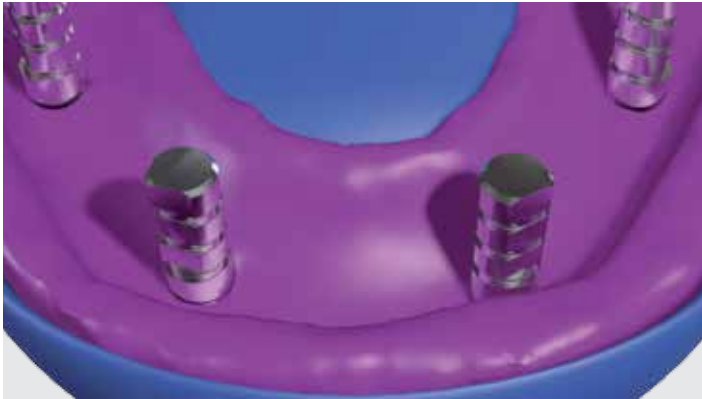

16 First, the laboratory prepares the impression for casting by means of the mounted Multi-Unit Laboratory Analogs.

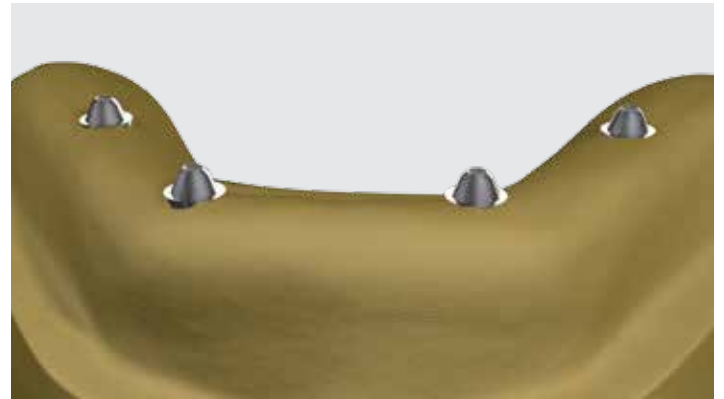

17 The laboratory fabricates a cast model from the impression by casting the impression.



18 Screw the Multi-Unit Caps calcinable (Ref. 3112) on the cast model...



19 ...and coat them with a wax release agent before modeling. The width of the Multi-Unit Cap calcinable exceeds by the bonding gap width of the Multi-Unit Cap titanium (Ref. 3111). The calcinable caps serve as support for the wax modeling.

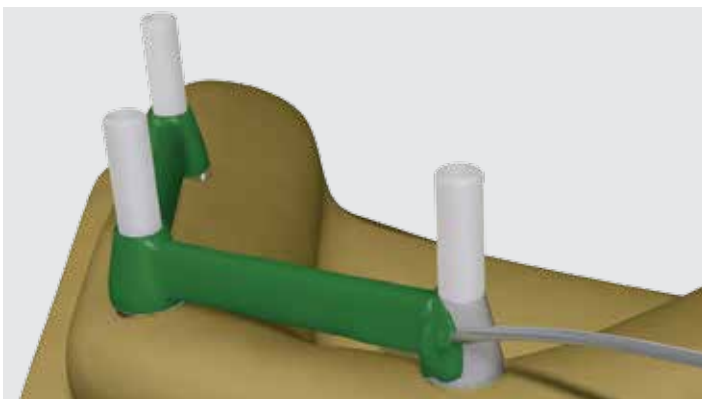

20 Then, model the wax bar.



21 Unscrew the Multi-Unit Caps calcinable and the wax framework. Press them out of the model.



22 After casting and treating the bar, glue it on the Multi-Unit Caps titanium (Ref. 3111) in the mouth...



23 ...or on the model. Take care that the connection is passively fitted. In this step, use the Bonding Aids (Ref. 7000).



24 In the last step, shorten the Multi-Unit Caps titanium (Ref. 3111) that stick out.



25 Glue the ready-made bar on the model.

Of course, the bar can also be milled with zircon. The Champions-Implants Juvora PEEK high-performance plastic secondary part is recommended.

5.1 FITTING THE FRAMEWORK



26 The ready-made bar work on the model, prepared for fitting the framework.



27 Before fitting the framework, remove the Protection Caps.



28 The bar is screwed in the patient's mouth at 30 Ncm. When the bar is placed passively fitted in the patient's mouth and all criteria are fulfilled, the bar is sent again to the laboratory for further processing.



29 Finally, unscrew the bar. Screw the Protection Caps again at 20 Ncm.



30 The dental technician fabricates the prosthesis conventionally on the bar and sends the ready-made prosthesis to the dentist.

5.3 FITTING THE PROSTHESIS



31 First, remove the Protection Caps...



32 ...and mount the bar. Tighten the screws at 30 Ncm.



33 Clip the ready-made prosthesis on to the bar.



34 Initial situation: Interdental gaps in Teeth sites 44 and 45. 2 Champions® (R)Evolution implants were inserted.



35 First, loosen the screw...



36 ...and remove the Shuttle from both implants with a Shuttle-Extractor.



37 Then, set the mounted Positioning Aid [see Figure 6/Page 6] for implants placed at an angle...



38 ...and then set the Multi-Units.



39 For preparing the impression with an open impression tray, manually screw the Impression Post Multi-Unit (Ref. 31222) and Fixation Screw Impression Post Multi-Unit (Ref. 30852).

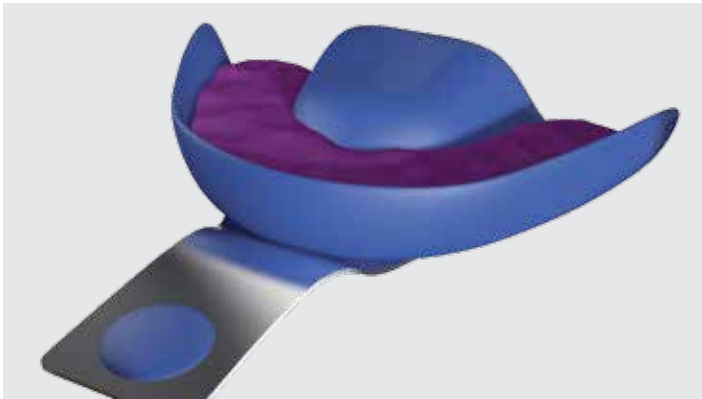

40 Prepare the impression tray for the open bite registration or use an individual impression tray.



41 Mold the Multi-Units with a casting compound...

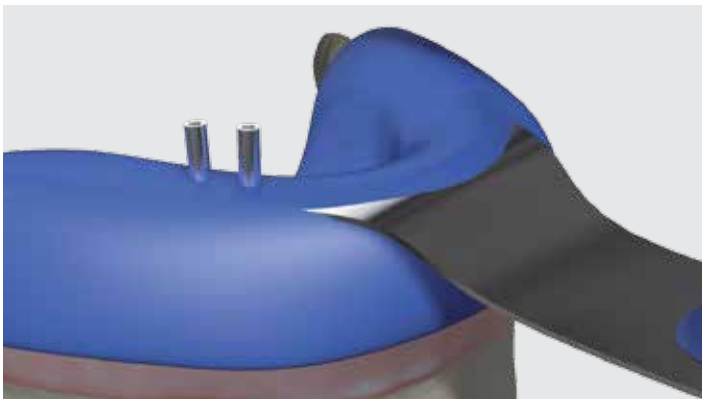

42 ...and remove the impression with an impression tray. The Impression Posts Multi-Unit (Ref. 31222) remain in the impression. Unscrew the Screws (Ref. 31223). Once the casting compound is hard, unscrew the Impression Post screws.



43 After removing the impression tray, leave the Impression Posts WIN!® PEEK (Ref. 3122) in the impression.



44 Finally, set the Protection Caps Multi-Unit (Ref. 31106), which are screwed with the Fixation Screw Multi-Unit Cap/LOC®/Protection Cap (Ref. 3085M) at 20 Ncm.



FABRICATING THE PROSTHODONTIC RESTORATION 6.1

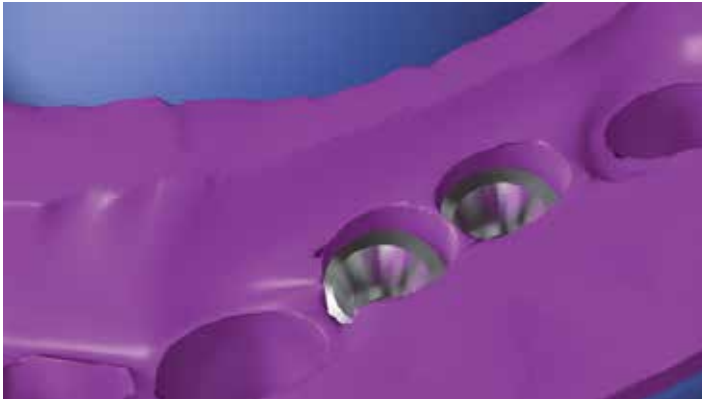

45 In the laboratory the impression...



46 ...is prepared with the mounted Multi-Unit Laboratory Analogs for casting.

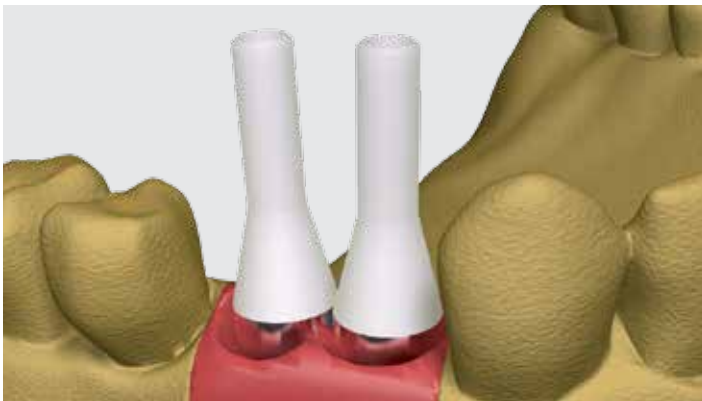

47 Screw the Multi-Unit Caps calcinable (Ref. 3112) on the cast impression with a gingiva mask...

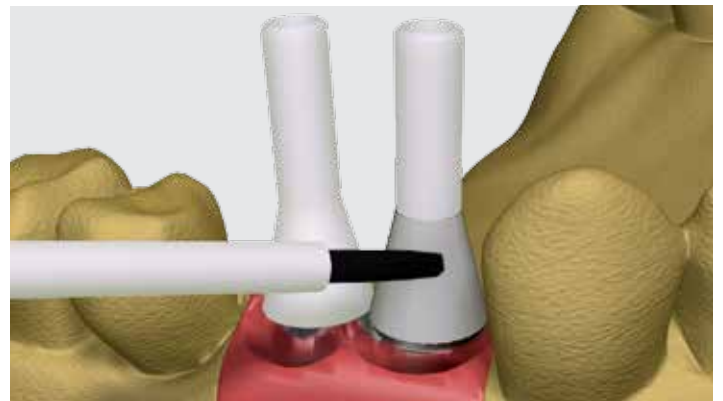

48 ...and before modeling, moisten them with a wax release agent.

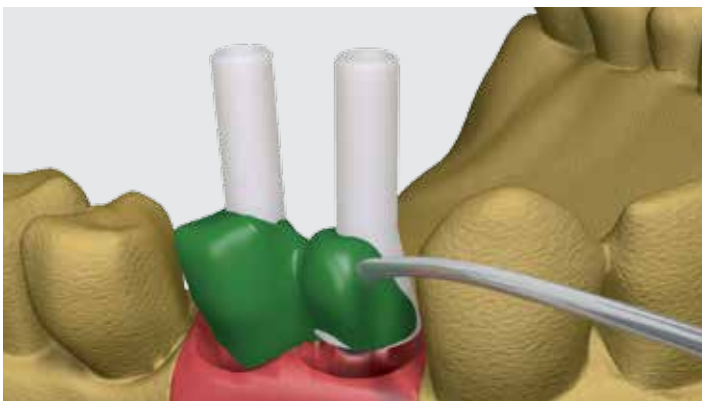

49 Finally, model the crown framework in wax.



50 Then, unscrew the Multi-Unit Caps POM (calcinable) (Ref. 3112) and press them out of the model. After casting, glue the original Multi-Unit Cap titanium (Ref. 3111). You can also cast with the Multi-Unit Cap calcinable. After casting, later processing can be necessary. By using the Multi-Unit Caps titanium, you make sure that the connection is passively fitted. For the further procedure, see Figures 22 to 25.

6.2 FITTING THE PROSTHODONTIC RESTORATION



51 View of the ready laminated prosthodontic restoration. Eventually, the framework is fitted before in an additional session.



52 The Fixation Screws Multi-Unit for Cap/ LOC®/Protection Cap (Ref. 3085M) are tightened at 30 Ncm.

More information about our products:
www.champions-implants.com

champions  implants

Champions-Implants GmbH
Champions Platz 1 | Im Baumfeld 30 | D-55237 Flonheim
fon +49 67 34 91 40 80 | fax +49 67 34 10 53
info@champions-implants.com

Step-by-step Multi-Units en 2017
4. März 2019, 11:12 vorm.

